

Series SQ

Tube/Metric, Thread/M, Rc(PT)



● 튜브의 착탈

Tube를 끝 부위가 닿도록 끼움으로써 확실한 접속이 이루어지며, 분리는 Sleeve를 손가락으로 누르고 Tube를 당기면 착탈시간은 불과 1~2초로 완료됩니다. Tube의 접속과 분리에 공구는 일체 필요치 않습니다.

● 좁은 공간에서 배관기능

SQH-T형 $\phi 4$, $\phi 6$, $\phi 8$ 제품을 체결할 때 육각 렌치로 사용토록 하였습니다. 나사부에 Seal처리가 되어 장착작업이 간편합니다. (나사부에 CHEMI Seal)

형식표시 방법

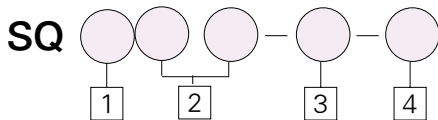

1 Model

2 적용 튜브 외경(mm)

- 04 : $\phi 4$
- 06 : $\phi 6$
- 08 : $\phi 8$
- 10 : $\phi 10$
- 12 : $\phi 12$

3 Tread Size

- M5 : M5
- 01 : PT(R)1/8
- 02 : PT(R)1/4
- 03 : PT(R)3/8
- 04 : PT(R)1/2
- * 00 : Tube Connect

4 Series

- Blank : Standard Type
- X2 : Copper-Free (동계불가형)

구조도

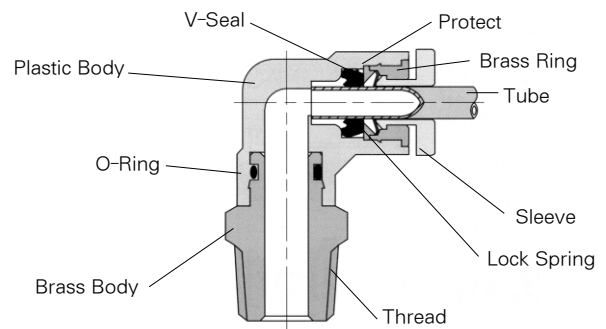

체결토크

Thread Size(접속나사)	Torque(토크)/kg · cm
PT 1/8	70~90
PT 1/4	120~140
PT 3/8	220~240
PT 1/2	280~300
M5	12

사양

사용유체	Air(공기)
최고사용압력	9.9 kgf/cm ² {990 kPa}
보증내압력	12.5 kgf/cm ² {1.250 kPa}
주위온도 및 사용유체온도	0~60℃(32~140°F)

ONE TOUCH FITTING

치수도

하프 유니온

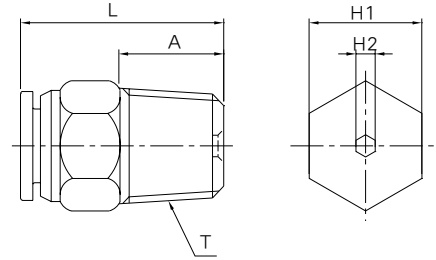

SQH Type

Unit: mm

Model	Tube size	T(Thread)	L	A	H1	H2
SQH04-01S	4	PT1/8	18.9	8	10	2
SQH04-02S	4	PT1/4	20.4	11	14	2.5
SQH04-M5	4	M5×P0.8	20.5	4	10	2
SQH04-M5A	4	M5×P0.8	21.2	4	10	2
SQH06-01S	6	PT1/8	20.9	8	12	4
SQH06-02S	6	PT1/4	22.9	11	14	4
SQH06-03S	6	PT3/8	22.9	12	17	4
SQH06-M5	6	M5×P0.8	20.9	4	12	2
SQH06-M5A	6	M5×P0.8	21.2	4	12	2
SQH08-01S	8	PT1/8	25.9	8	14	5
SQH08-02S	8	PT1/4	24.9	11	14	6
SQH08-03S	8	PT3/8	22.9	12	17	6
SQH08-04S	8	PT1/2	26.7	15	22	6
SQH10-01S	10	PT1/8	28.5	8	17	—
SQH10-02S	10	PT1/4	29.8	11	17	—
SQH10-03S	10	PT3/8	26.3	12	17	—
SQH10-04S	10	PT1/2	26.1	15	22	—
SQH12-02S	12	PT1/4	33.3	11	19	—
SQH12-03S	12	PT3/8	30.7	12	19	—
SQH12-04S	12	PT1/2	31.9	15	22	—

치수도

엘보 유니온

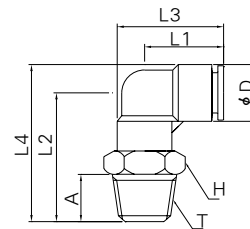

SQL Type

Unit: mm

Model	Tube size	T (Thread)	L1	L2	L3	L4	A	H	D
SQL04-01S	4	PT1/8	17.1	24.9	22.2	30	8	10	10.2
SQL04-02S	4	PT1/4	17.1	27.9	22.2	33	11	14	10.2
SQL04-M5	4	M5×P0.8	17	17.9	21.1	23	4	8	10.2
SQL06-01S	6	PT1/8	18.4	26	24.3	32.3	8	12	12.6
SQL06-02S	6	PT1/4	18.4	29	24.3	35.3	11	14	12.6
SQL06-03S	6	PT3/8	18.4	30	24.3	36.3	12	17	12.6
SQL06-M5	6	M5×P0.8	18	17.9	22.1	24.2	4	8	12.6
SQL08-01S	8	PT1/8	20.4	27	27.2	34.4	8	14	14.7
SQL08-02S	8	PT1/4	20.4	29.9	27.2	37.3	11	14	14.7
SQL08-03S	8	PT3/8	20.4	30.9	27.2	38.3	12	17	14.7
SQL08-04S	8	PT1/2	20.4	35.4	27.2	42.8	15	22	14.7
SQL10-01S	10	PT1/8	23.9	30	32.4	38.8	8	17	17.6
SQL10-02S	10	PT1/4	23.9	33	32.4	41.8	11	17	17.6
SQL10-03S	10	PT3/8	23.9	34	32.4	42.8	12	17	17.6
SQL10-04S	10	PT1/2	23.9	38.5	32.4	47.3	11	19	17.6
SQL12-02S	12	PT1/4	24.9	35	34	45	11	19	20
SQL12-03S	12	PT3/8	24.9	36	34	46	12	19	20
SQL12-04S	12	PT1/2	24.9	40.5	34	50.5	15	22	20

치수도

T형 유니온

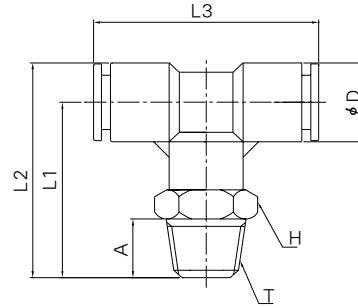

SQT Type

Unit: mm

Model	Tube size	T (Thread)	L1	L2	L3	A	H	D
SQT04-01S	4	PT1/8	24.9	30	34.2	8	10	10.2
SQT04-02S	4	PT1/4	27.9	33	34.2	11	14	10.2
SQT04-M5	4	M5×P0.8	22.4	27.5	34.2	4	10	10.2
SQT06-01S	6	PT1/8	26	32.3	36.8	8	12	12.6
SQT06-02S	6	PT1/4	29	35.3	36.8	11	14	12.6
SQT06-03S	6	PT3/8	30	36.3	36.8	12	17	12.6
SQT06-M5	6	M5×P0.8	23.5	29.8	36.8	4	12	12.6
SQT08-01S	8	PT1/8	27	34.4	40.8	8	14	14.7
SQT08-02S	8	PT1/4	29.9	37.3	40.8	11	14	14.7
SQT08-03S	8	PT3/8	30.9	38.3	40.8	12	17	14.7
SQT08-04S	8	PT1/2	35.4	42.8	40.8	15	22	14.7
SQT10-01S	10	PT1/8	30	38.8	47.8	8	17	17.6
SQT10-02S	10	PT1/4	33	41.8	47.8	11	17	17.6
SQT10-03S	10	PT3/8	34	42.8	47.8	12	17	17.6
SQT10-04S	10	PT1/2	38.5	47.3	47.8	15	22	17.6
SQT12-02S	12	PT1/4	35	45	49.8	11	19	20
SQT12-03S	12	PT3/8	36	46	49.8	12	19	20
SQT12-04S	12	PT1/2	40.5	50.5	49.8	15	22	20

치수도

리듀서 스트레이트

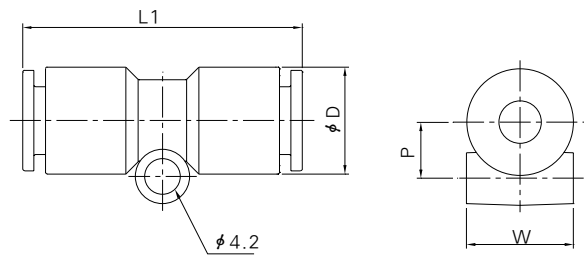

SQH Type

Unit: mm

Model	Tube size	L1	P	D	W
SQH04-00	4	31.8	5.8	10.2	10.2
SQH06-00	6	33.6	6.6	12.6	12.6
SQH08-00	8	35.8	7.6	14.7	14.7
SQH10-00	10	41.2	8.9	17.6	17.6
SQH12-00	12	43.2	9.8	20	20

ONE TOUCH FITTING

치수도

엘보 유니온

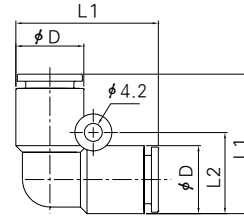

SQL Type

Unit: mm

Model	Tube size	L1	L2	D
SQL04-00	4	22.2	12.2	10.2
SQL06-00	6	24.6	14.7	12.6
SQL08-00	8	27.8	16.8	14.7
SQL10-00	10	32.7	19.6	17.6
SQL12-00	12	35.4	22	20

치수도

T 형 유니온

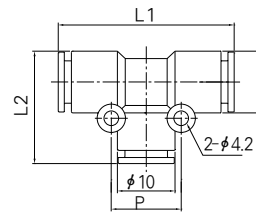

SQT Type

Unit: mm

Model	Tube size	L1	L2	P	D
SQT04-00	4	34.2	22.2	14.2	10.2
SQT06-00	6	36.6	24.6	16.8	12.6
SQT08-00	8	40.8	27.8	18.8	14.7
SQT10-00	10	47.8	32.7	21.6	17.6
SQT12-00	12	46.8	34.9	24	20

치수도

서비스 T형 유니온

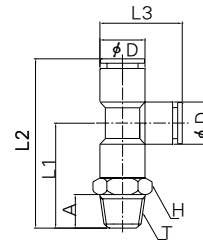

SQY Type

Unit: mm

Model	Tube size	T (Thread)	L1	L2	L3	A	H	D
SQY04-M5	4	PT1/8	24.8	41.9	22.2	8	10	10.2
SQY04-01S	4	PT1/4	27.8	44.9	22.2	11	14	10.2
SQY04-02S	4	M5×P0.8	22.3	39.4	22.2	4	10	10.2
SQY06-M5	6	PT1/8	26	44.3	24.6	8	12	12.6
SQY06-01S	6	PT1/4	29	47.3	24.6	11	14	12.6
SQY06-02S	6	PT3/8	30	48.3	24.6	12	17	12.6
SQY06-03S	6	M5×P0.8	23.5	41.8	24.6	4	12	12.6
SQY08-01S	8	PT1/8	27	47.4	27.8	8	14	14.7
SQY08-02S	8	PT1/4	29.9	50.3	27.8	11	14	14.7
SQY08-03S	8	PT3/8	30.9	51.3	27.8	12	17	14.7
SQY08-04S	8	PT1/2	35.4	55.8	27.8	15	22	14.7
SQY10-01S	10	PT1/8	30	53.9	32.7	8	17	17.6
SQY10-02S	10	PT1/4	33	56.9	32.7	11	17	17.6
SQY10-03S	10	PT3/8	34	57.9	32.7	12	17	17.6
SQY10-04S	10	PT1/2	38.5	62.4	32.7	15	22	17.6
SQY12-02S	12	PT1/4	35	59.9	34.9	11	19	20
SQY12-03S	12	PT3/8	36	60.9	34.9	12	19	20
SQY12-04S	12	PT1/2	40.5	65.4	34.9	15	22	20

치수도

메스 유니온

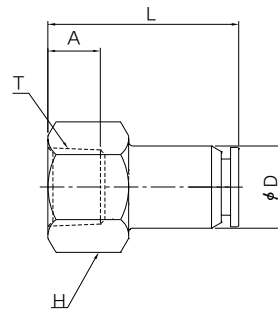

SQF Type

Unit: mm

Model	Tube size	T (Thread)	L	A	H	D
SQF04-01	4	PT1/8	24.5	6.5	14	10.2
SQF04-02	4	PT1/4	27.5	9.5	17	10.2
SQF06-01	6	PT1/8	25	6.5	14	12.6
SQF06-02	6	PT1/4	28	9.5	17	12.6
SQF06-03	6	PT3/8	29	10.5	22	12.6
SQF08-01	8	PT1/8	26.1	6.5	17	14
SQF08-02	8	PT1/4	29.1	9.5	17	14
SQF08-03	8	PT3/8	30.1	10.5	22	14
SQF08-04	8	PT1/2	35	13.5	26	14
SQF10-01	10	PT1/8	28.3	6.5	17	16.4
SQF10-02	10	PT1/4	31.8	9.5	17	16.4
SQF10-03	10	PT3/8	32.8	10.5	22	16.4
SQF10-04	10	PT1/2	37	13.5	26	16.4
SQF12-02	12	PT1/4	33.3	9.5	19	19
SQF12-03	12	PT3/8	34.3	10.5	22	19
SQF12-04	12	PT1/2	37.3	13.5	26	19

치수도

판넬용 메스 유니온

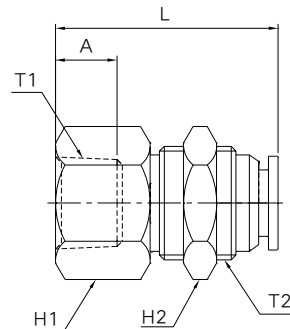

SQE Type

Unit: mm

Model	Tube size	T (Thread)	T2 (Thread)	L	A	H1	H2
SQE04-01	4	PT1/8	12×P1	24.5	6.5	14	14
SQE06-01	6	PT1/8	14×P1	25	6.5	17	17
SQE06-02	6	PT1/4	14×P1	28	9.5	17	17
SQE08-01	8	PT1/8	16×P1	26.1	6.5	19	19
SQE08-02	8	PT1/4	16×P1	29.1	9.5	19	19
SQE08-03	8	PT3/8	16×P1	30.1	13.5	19	19
SQE10-02	10	PT1/4	20×P1	31.8	9.5	24	24
SQE10-03	10	PT3/8	20×P1	32.8	10.5	24	24
SQE12-02	12	PT1/4	22×P1	34.1	9.5	26	26
SQE12-03	12	PT3/8	22×P1	34.3	10.5	26	26
SQE12-04	12	PT1/2	22×P1	38	13.5	26	26

ONE TOUCH FITTING

치수도

판넬용 유니온

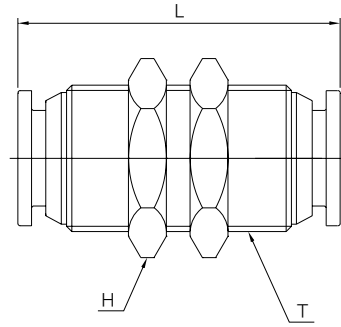
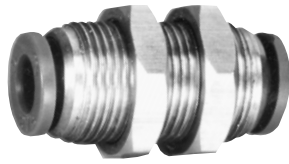

SQE Type

Unit: mm

Model	Tube size	T (Thread)	L	H
SQE04-00	4	M12×P1	30.5	14
SQE06-00	6	M14×P1	31.5	17
SQE08-00	8	M16×P1	34.2	19
SQE10-00	10	M20×P1	38.6	24
SQE12-00	12	M22×P1	40.6	26

와세사리

치수도

롱 엘보 유니온

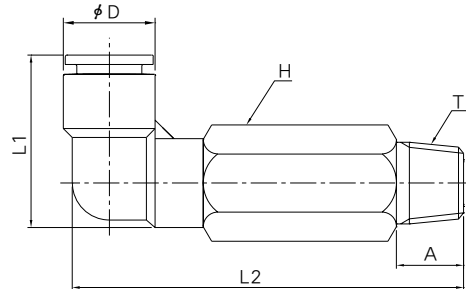

SQW Type

Unit: mm

Model	Tube size	T (Thread)	L1	L2	A	H	D
SQW04-01S	4	PT1/8	22.2	49	8	10	10.2
SQW04-02S	4	PT1/4	22.2	47	11	14	10.2
SQW04-M5	4	M5×P0.8	22.2	36.5	4	8	10.2
SQW06-01S	6	PT1/8	24.3	46.3	8	12	12.6
SQW06-02S	6	PT1/4	24.3	49.3	11	14	12.6
SQW06-03S	6	PT3/8	24.3	50.3	12	17	12.6
SQW06-M5	6	M5×P0.8	24.3	38.8	4	8	12.6
SQW08-01S	8	PT1/8	27.2	50.3	8	14	17.4
SQW08-02S	8	PT1/4	27.2	53.3	11	14	17.4
SQW08-03S	8	PT3/8	27.2	54.3	12	17	17.4
SQW08-04S	8	PT1/2	27.2	58.8	15	22	17.4
SQW10-01S	10	PT1/8	32.4	57.8	8	17	17.6
SQW10-02S	10	PT1/4	32.4	60.8	11	17	17.6
SQW10-03S	10	PT3/8	32.4	62.8	12	17	17.6
SQW10-04S	10	PT1/2	32.4	68.3	15	22	17.6
SQW12-02S	12	PT1/4	34	67	11	19	20
SQW12-03S	12	PT3/8	34	68	12	19	20
SQW12-04S	12	PT1/2	34	71.5	15	22	20

치수도

리듀서 유니온 Y

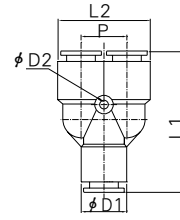

SQU Type

Unit: mm

Model	Tube size	L1	L2	P	D1	D2
SQU04-00	4	33.8	20.4	10.2	10.2	3.5
SQU06-00	6	35.1	25	12.4	12.6	3.2
SQU08-00	8	39.3	29.1	14.4	14.7	4.3
SQU10-00	10	45.2	34.8	17.2	17.6	4.3
SQU12-00	12	47.3	39.4	19.4	20	4.3

치수도

유니온 Y

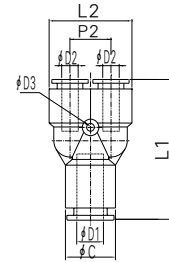

QU Type

Unit: mm

Model	Tube O/D		D3	L1	L2	P	C
	D1	D2					
SQU04-06	6	4	3.5	34.4	20.4	10.2	12.6
SQU06-08	8	6	4.2	36.2	25	12.4	14.7
SQU08-10	10	8	4.3	41	29.1	14.4	17.6
SQU10-12	12	10	4.3	46.2	46.2	17.2	20

치수도

서비스 Y형 유니온

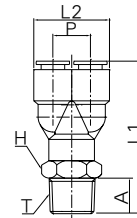

SQU Type

Unit: mm

Model	Tube size	T (Thread)	L1	L2	A	H	P
SQU04-01S	4	PT1/8	41.5	20.4	8	10	10.1
SQU04-02S	4	PT1/4	44.5	20.4	11	14	10.1
SQU04-M5	4	M5×0.8	39	20.4	4	10	10.1
SQU06-01S	6	PT1/8	42.5	24.8	8	12	12.2
SQU06-02S	6	PT1/4	45.5	24.8	11	14	12.2
SQU06-03S	6	PT3/8	46.5	24.8	12	17	12.2
SQU06-M5	6	M5×0.8	40	24.8	4	12	12.2
SQU08-01S	8	PT1/8	44.8	29.1	8	14	14.4
SQU08-02S	8	PT1/4	47.8	29.1	11	14	14.4
SQU08-03S	8	PT3/8	48.7	29.1	12	17	14.4
SQU08-04S	8	PT1/2	53.2	29.1	15	22	14.4
SQU10-01S	10	PT1/8	49.9	34.8	8	17	17.2
SQU10-02S	10	PT1/4	52.9	34.8	11	17	17.2
SQU10-03S	10	PT3/8	53.9	34.8	12	17	17.2
SQU10-04S	10	PT1/2	58.4	34.8	15	22	17.2
SQU12-02S	12	PT1/4	53.9	39.4	11	19	19.4
SQU12-03S	12	PT3/8	54.9	39.4	12	19	19.4
SQU12-04S	12	PT1/2	59.4	39.4	15	22	19.4

ONE TOUCH FITTING

치수도

리듀서 스트레이트

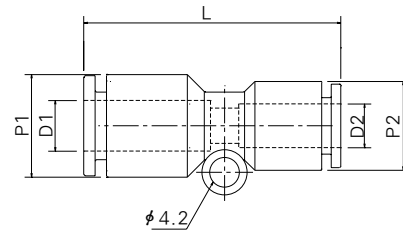

SQH Type

Unit: mm

Model	Tube O/D		L	P1	P2
	D1	D2			
SQH04-06	6	4	33.1	12.6	10.2
SQH06-08	8	6	34.7	14.7	12.6
SQH08-10	10	8	38	17.6	14.7
SQH10-12	12	10	41.2	20	17.6

치수도

스트레이트 엘보

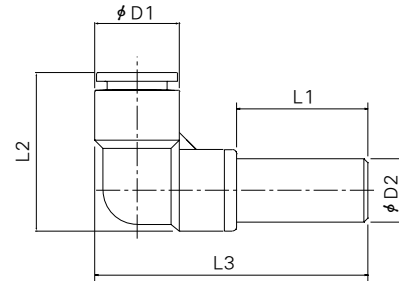
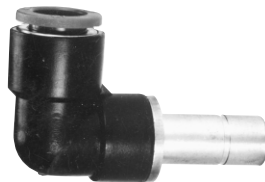

SQL Type

Unit: mm

Model	Tube size	D1	D2	L1	L2	L3
SQL04-99	4	10.2	4	17.2	22.2	36.7
SQL06-99	6	12.6	6	19	24.3	40.8
SQL08-99	8	14.7	8	19.5	27.2	43.35
SQL10-99	10	17.6	10	21.5	32.4	50.3
SQL12-99	12	20	12	23.5	34	55.5

치수도

스트레이트

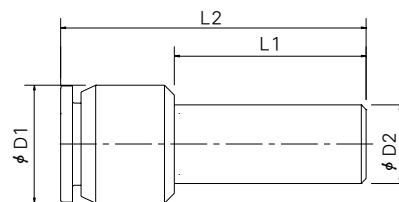
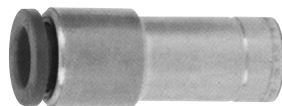

SQJ Type

Unit: mm

Model	Tube size	L1	L2	D1	D2
SQJ04-06	4	1.8	30	10	6
SQJ04-08	4	18.5	30.5	10	8
SQJ06-08	6	19.5	32	12	8
SQJ06-10	6	21	34.5	12	10
SQJ06-12	6	22	36	12	12
SQJ08-10	8	20.5	34.5	14	10
SQJ08-12	8	23	36	14	12
SQJ10-12	10	23	39	17	12

치수도

유니버설 엘보 유니온

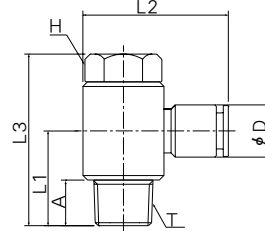

SQV Type

Unit: mm

Model	Tube size	T (Thread)	L1	L2	L3	A	H	D
SQV04-01S	4	PT1/8	20.3	29.3	29.3	8.4	14	10.2
SQV04-02S	4	PT1/4	26.3	33.3	35.6	11.8	17	10.2
SQV04-M5	4	M5×0.8	13.7	24.3	21.2	5.2	8	10.2
SQV06-01S	6	PT1/8	20.3	29.8	29.3	7.6	14	12.6
SQV06-02S	6	PT1/4	26.3	23.5	35.6	11.8	17	12.6
SQV06-03S	6	PT3/8	29.5	38.8	40.6	12.1	21	12.6
SQV06-M5	6	M5×0.8	13.7	24.8	21.2	5.2	8	12.6
SQV08-01S	8	PT1/8	19.5	30.9	29.3	7.6	14	14.7
SQV08-02S	8	PT1/4	25.5	34.9	35.6	11.8	17	14.7
SQV08-03S	8	PT3/8	29.7	39.8	40.6	12.1	21	14.7
SQV08-04S	8	PT1/2	25.8	43.9	41.3	15.3	24	14.7
SQV10-02S	10	PT1/4	27.5	42.1	39.6	11.1	21	17.6
SQV10-03S	10	PT3/8	28.5	42.1	40.5	12.1	21	17.6
SQV10-04S	10	PT1/2	25.8	45.3	41.3	15.3	24	17.6
SQV12-02S	12	PT1/4	26.1	43.5	39.6	11.2	21	20
SQV12-03S	12	PT3/8	27.1	43.5	40.5	12.2	21	20
SQV12-04S	12	PT1/2	25.8	46.3	41.3	15.3	24	20

치수도

십자형 리듀서

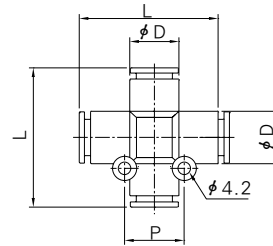

SQZ Type

Unit: mm

Model	Tube O/D	D	P	L
SQZ04-00	4	10.2	14.2	34.2
SQZ06-00	6	12.6	16.8	36.6
SQZ08-00	8	14.7	18.8	40.8
SQZ10-00	10	17.6	21.6	47.8
SQZ12-00	12	20	24	50.8

치수도

플랜지 유니온 Y

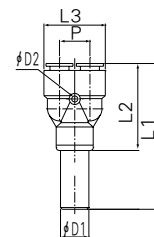

SQU Type

Unit: mm

Model	Tube size	L1	L2	L3	P	D1	D2
SQU04-99	4	49.5	39.1	20.4	10.2	4	3.5
SQU06-99	6	52.6	40.4	25	12.4	6	3.2
SQU08-99	8	57.3	44.8	29.1	14.4	8	4.3
SQU10-99	10	65.7	52.7	34.8	17.2	10	4.3
SQU12-99	12	69.8	54.8	39.4	19.4	12	4.3

TWO TOUCH FITTING

치수도

유니온 "I"

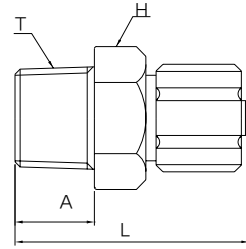
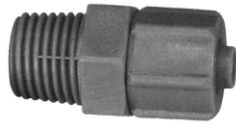

SQ2H Type

Unit: mm

Model	Tube O/D	Tube I/D	T (Thread)	A	L	H
SQ2H04-01	4	2.5	PT1/8	8	24.6	12
SQ2H06-01	6	4	PT1/8	8	27.7	12
SQ2H06-02	6	4	PT1/4	11	31.7	16
SQ2H08-01	8	5.5	PT1/8	8	27.7	13
SQ2H08-02	8	5.5	PT1/4	11	31.7	16
SQ2H08-03	8	5.5	PT3/8	12	33	18
SQ2H10-02	10	6.5	PT1/4	11	32.2	17
SQ2H10-03	10	6.5	PT3/8	12	33.4	17
SQ2H12-02	12	9	PT1/4	11	34.9	17
SQ2H12-03	12	9	PT3/8	12	36.1	19

치수도

유니온 "L"

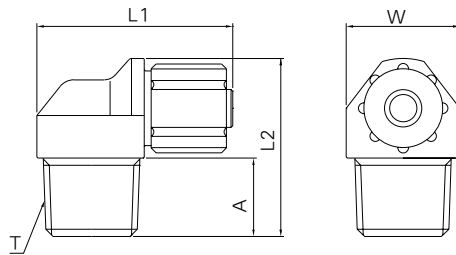

SQ2L Type

Unit: mm

Model	Tube O/D	Tube I/D	T (Thread)	A	L1	L2	W
SQ2L04-01	4	2.5	PT1/8	8	23.6	20	12
SQ2L06-01	6	4	PT1/8	8	26.7	20	12
SQ2L06-02	6	4	PT1/4	11	30.1	23	16
SQ2L08-01	8	5.5	PT1/8	8	28.7	22	14
SQ2L08-02	8	5.5	PT1/4	11	30.1	25	16
SQ2L08-03	8	5.5	PT3/8	12	32.7	26	18
SQ2L10-02	10	6.5	PT1/4	11	30.6	27	17
SQ2L10-03	10	6.5	PT3/8	12	33.2	28	18
SQ2L12-02	12	9	PT1/4	11	35.9	30	19
SQ2L12-03	12	9	PT3/8	12	36.9	31	19

치수도

유니온 "T"

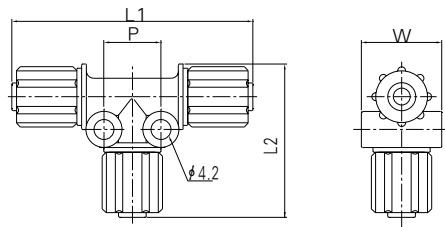

SQ2T Type

Unit: mm

Model	Tube O/D	Tube I/D	P	L1	L2	W
SQ2T04-00	4	2.5	10	40.8	23.4	11
SQ2T06-00	6	4	12	48.8	30.3	14
SQ2T08-00	8	5.5	12	50.8	32.3	17
SQ2T10-00	10	6.5	13	51.5	36	20
SQ2T12-00	12	9	14.5	57.9	40.3	22